

The Winning Force

***DURMA***

# PANEL BENDER

## Bending Center



- Full Servo-Electric System
- Full Automatic
- Stabil Process (HQ Bend)
- Clever Consumption
- Rapid Setup



# **DURMA** The Winning Force



As a total supplier for sheet metal manufacturing with almost 60 years of experience, Durma understands and recognizes the challenges, requirements and expectations of the industry. We strive to satisfy the ever higher demands of our customers by continuously improving our products and processes while researching and implementing the latest technologies.

In our three production plants with a total of 150.000 m<sup>2</sup>, we dedicate 1,000 employees to delivering high quality manufacturing solutions at the best performance-to-price ratio in the market.

From the innovations developed at our Research & Development Center to the technical support given by our worldwide distributors, we all have one common mission: to be your preferred partner.

Present Durmazlar machines with **DURMA** name to the world.



1  
High technology,  
modern production  
lines



2  
Top quality  
components



3  
High quality  
machines designed  
in R&D Centre

# The Winning Force

Full Servo-Electric System

Full Automatic

Stabil Process (High Quality)

Clever Consumption System

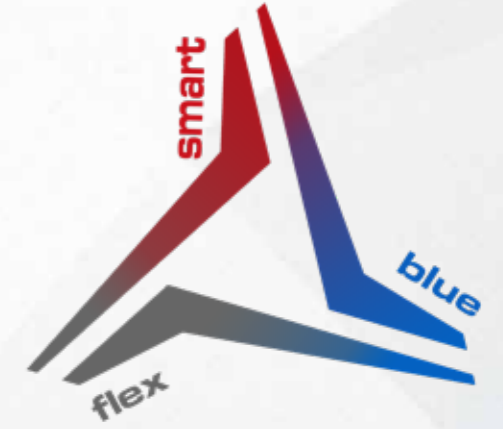

## Perfectly equipped for bending Energy efficient solutions

Precise bend with, Maximum speed, safety full automatic tool changing and minimum set-up time.

With its easy to use control units, rigid body frame, perfect design, high efficiency, multiple tool usage solutions,

Easy to  
Use

Ergonomic

Efficient

Fast

Reliable  
Brand

Compact Solution

Ergonomic and Safe Working Area

Energy safety with clever consumption system

Regular Production Independent From the Operator

Stabil Process «No Influence» From the Machine Thermal Conditions

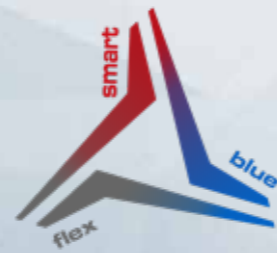

# blue bend

# Smart, Flex, Blue

DURMA Panel Bender, designed with high technology to increase efficiency on precise part bending.  
 Quality approved components used.  
 Stress relieved made on bodies for long life and precise bending.

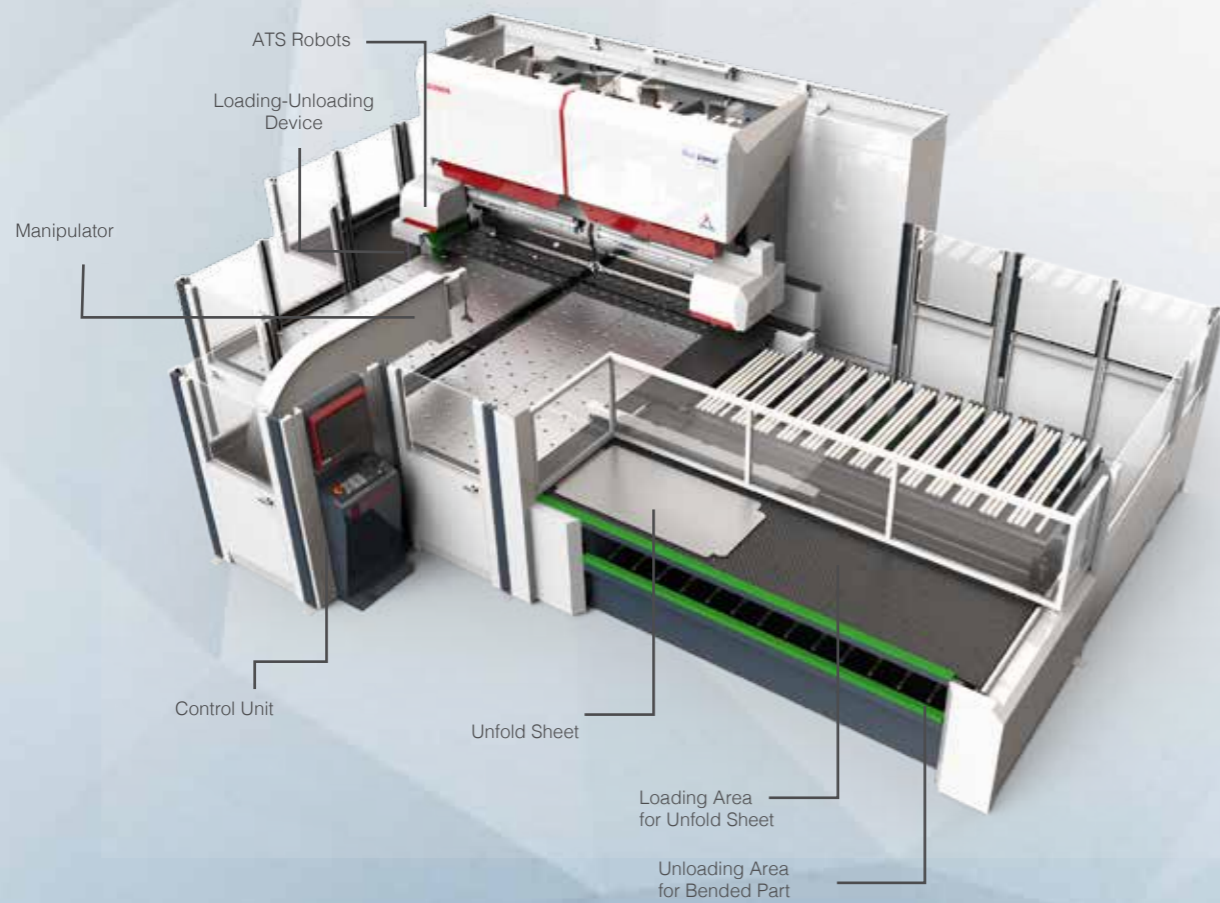

## Bending Area

The bend occurs by negative and positive bending with the sheet bending tools compressed by the holder tools.  
 A minimum approach to the bending axis is achieved by bending and pressing tools with special geometries.

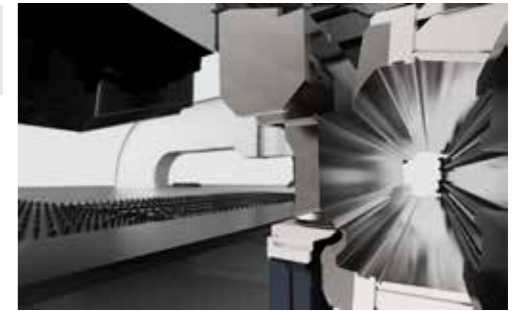

Bending Area

## Reference Pins – Centering Device

The centering device by the reference pins are points of where we adjust the correct position of the sheet metal (unfold part) before manipulator clamps hold



Referans Pins – Centering Device

## LUD – Loading / Unloading Device

Loading – Unloading Device pushes the part which finished all of bending operations on it outside of the working area. In the same time it can bring the new unfold part center of the working area.

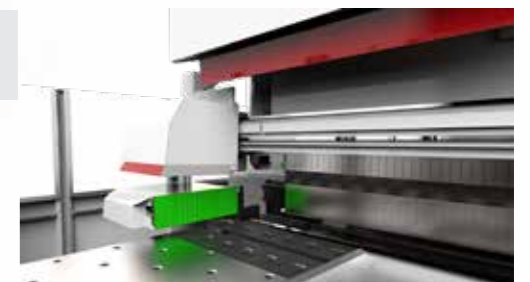

LUD (Push Support is closed)

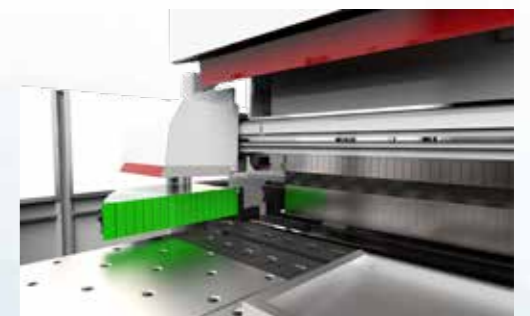
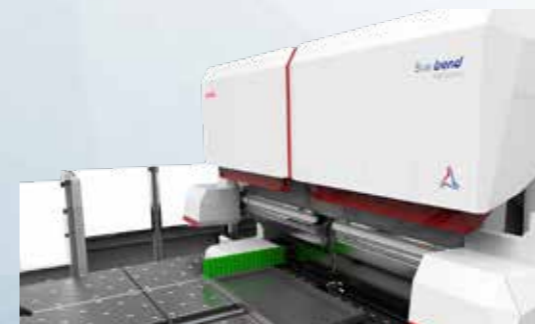

LUD (Push Support is open)

# Standart Bending Tools

Bending performance increased using with high quality holding and bending tools .

DURMA is your solution partner with various tool options.

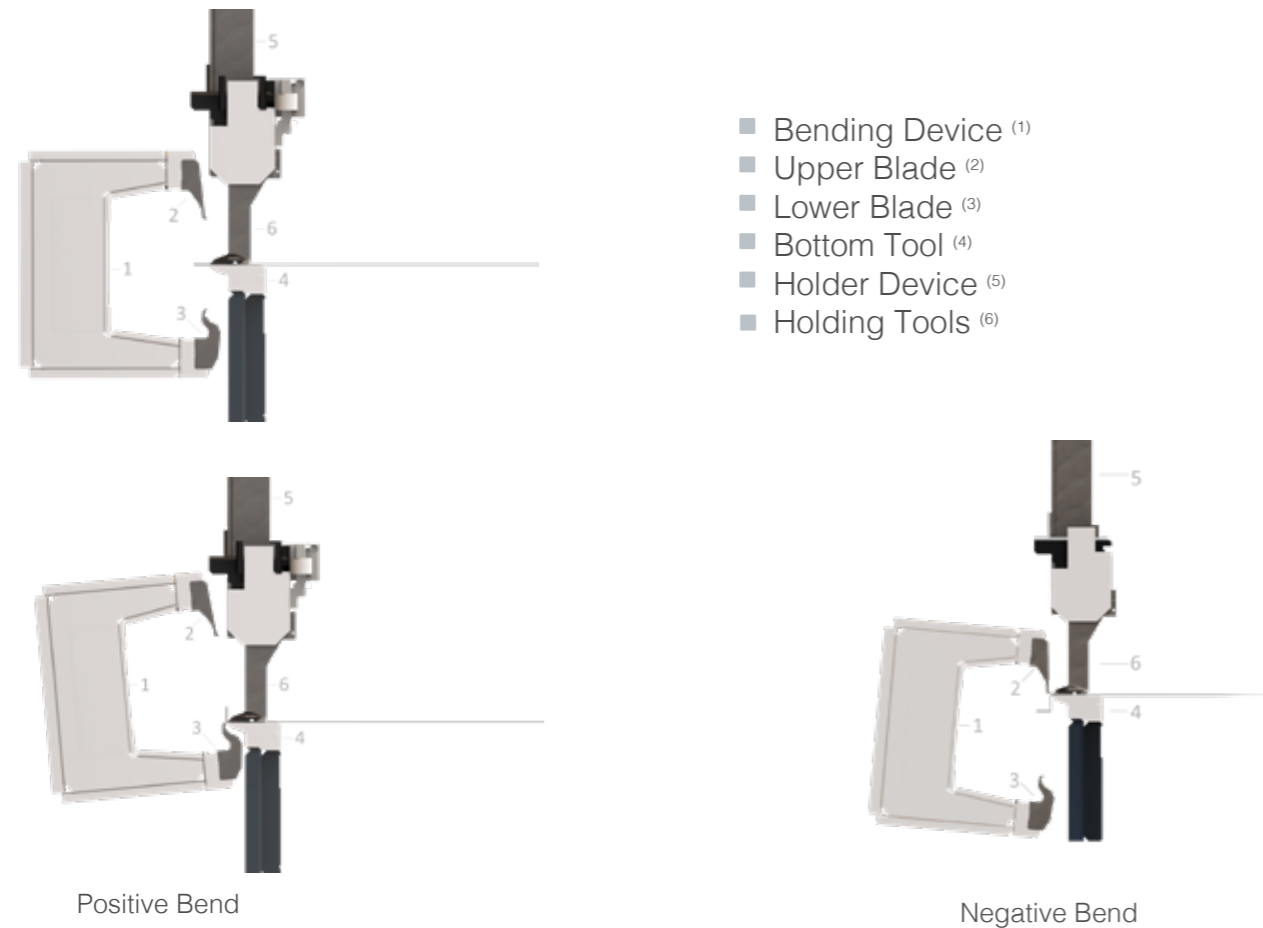

Tool Condition for Max. Bending Length

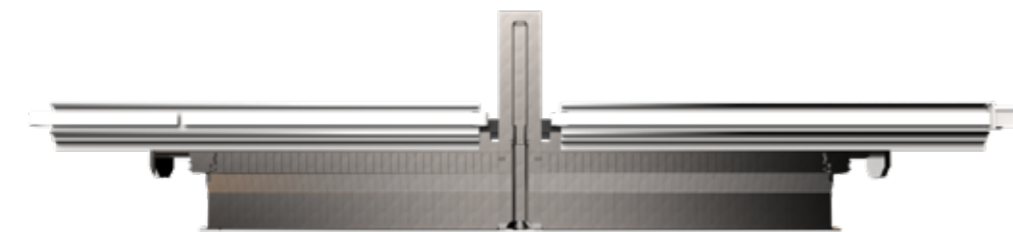

Tool Condition for Intermediate Bending Length

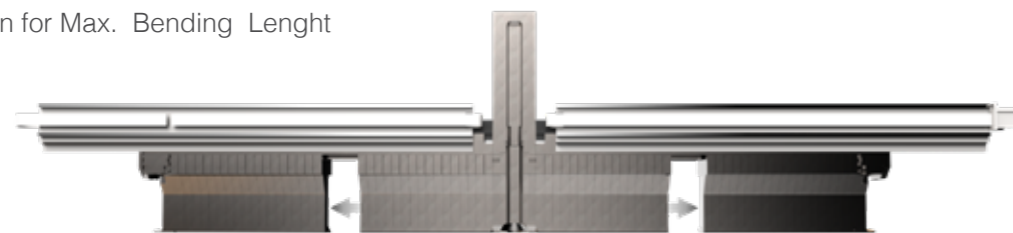

## ATS – Automatic Tools Set-Up

In order to bend components with different dimensions the upper tool needs to be changed; the option ATS make this operation automaticly.

The mechanism in the central holder device changes the combination of tools for fine variation, the two side robots change the coarse composition and move the end tools.



## Manipulator - Clamp

Manipulator is the system that provides the management of the clamping the incoming sheet from the loading area between the lower and upper clamps. The sheet pressed between the clamps is first referenced by being imposed on the pins on the centering device, then claps the twist according to twist steps.



## LUS – Loading / Unloading System

The loading unloading system has a ergonomic concept that allows you to put on the bending part from the front of the loading site. The benden part which prepared for the bend allows you to take from the bottom of the part area.

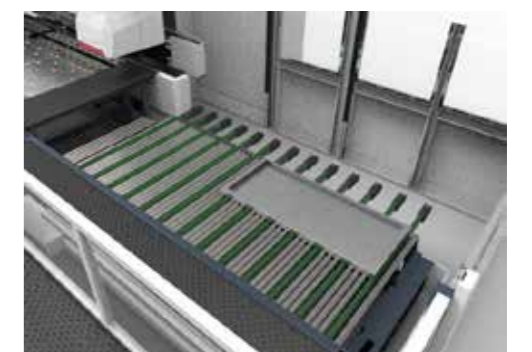
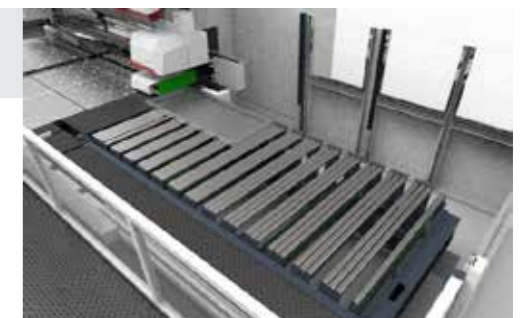

## AHD- Auxiliary Holder Device

Auxiliary holder device is a very useful option that permit to automatically change during bending cycle the geometry of the upper tool with an alternatively one when needed, increasing the flexibility of the machine in bending capability. This option with its accessories is used to make partial bend, narrow profile deep bend, panel with embossing, hidden negative bend and more.

The AHD allows to automatically changing the geometry of the upper tool with an alternatively one when needed.

The option consist in a long bar (according to the machine size) moved by 2 arms. There are 2 basic positions. The "stand by" position of the bar is on the upper side of the machine. The bar working position is placed under the upper tools by a junction system. The bar is prepared to contain all different type of tooling that have to be easily manually set up according to the components.



## ABD – Auxiliary Bending Device

This device is a very useful option that enlarge the bending capability of the machine.

This option with its accessories is used to make bend internal the pannel contour,corner junction, partial bend, irregularly shaped panels and more.

This option is located inside the C-frame and consists of four carriages sliding on linear guides parallel to the bending line and moved independently by two servomotors.

The movement is made by belt driving system, precise and reliable.

Every pair of carriage can moves from one side to the other covering all the machine length.



## Control Panel

The Sinumerik 840DSL CNC controller is an efficient 64-bit microprocessor system with an integrated PC. The controller has a Durma operator interface and frame bending database for all standard bending applications. The database includes the bending parameters for standard materials (steel, stainless steel, aluminium) for common thickness ranges. Based on these reference values the operator can easily improve the bending quality for different types of materials.



## Easy to Use Bending Management

- Step by step easy programming.
- Creating program directly from DXF Drawing.
- 14 Different material type.
- For every each standart, totally 278 different metarial name.
- Sheet thinksness and folio option definitions.
- Editing, cleaning on DFX Drawing.
- Automatic detection for bends, part floor, bending sides.
- Definition and editing for loading parameters, shiftings can be done if necessary.
- Referencing can be easily done with visual objects.
- Parametric corrections can be done if necessary.
- Positive, negative, auxiliary, smash bend, big radius and air bend can be created with on click.
- Holder device tool management can be done.
- Recenter, cartesian, reposition can be done.
- Auxiliary tool composition can be done.
- Collision detection and machine simulation can be done.
- Bending scenerio can be followed step by step.
- Bending definition window.
- Bending simulation.
- Bending program can be exported.
- All settings, bend can be saved and reused.

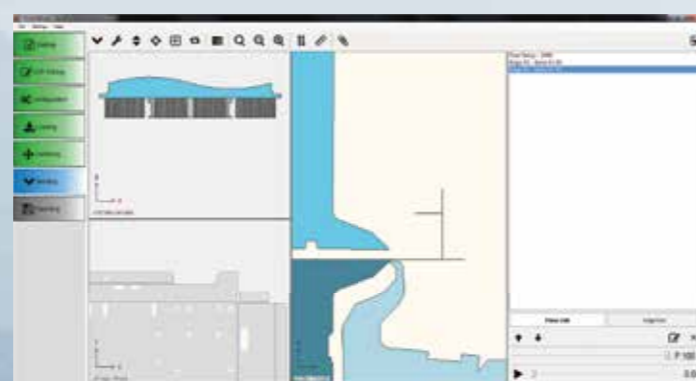

## User-Friendly interface and 2D simulation

- New bending programs can be added to tasklist, production counts can be setted, different parts can be produced.
- Bending programs can be loaded from machine memory of USB memory stick.
- Bending programs which are placed in the machine memory, can be viewed as folder tree.
- The part which will be bended can be previewed.
- Passing through bending can be done.
- Machine axis positions can be viewed online with machine simulation.
- Tool composition can be managed and previewed online.
- Machine switch and sensor can be viewed and managed online.
- Movement, axis, setup etc. Parameters of machine can be edited, backedup, exported.

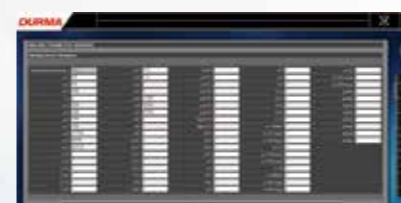

- The selected program, production status, instantaneous speed and power of the machine can be manitored online.
- The final bending parts can be viewed from the panel display.
- All bending parts can be taken from the reports page..
- Details of bending parts can be displayed.
- Machine alarms are archives. Posture reasons can be examined.





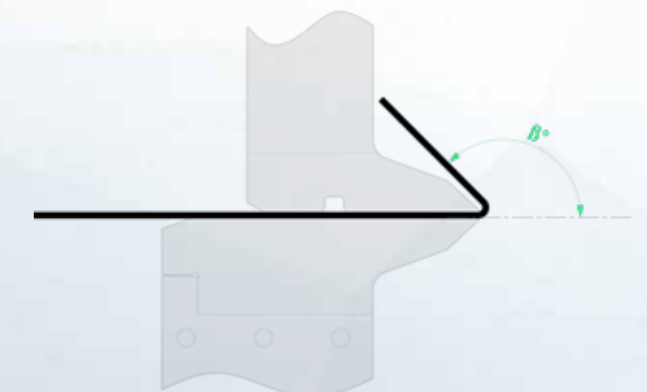
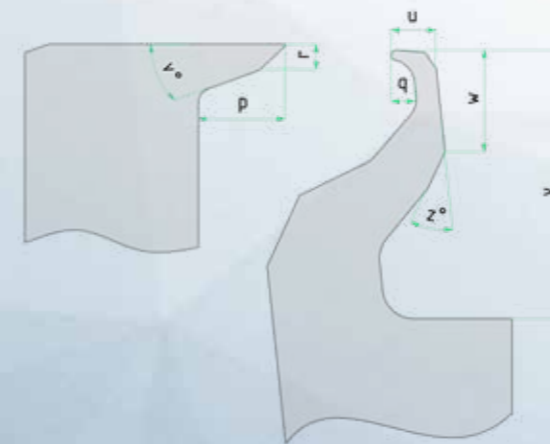
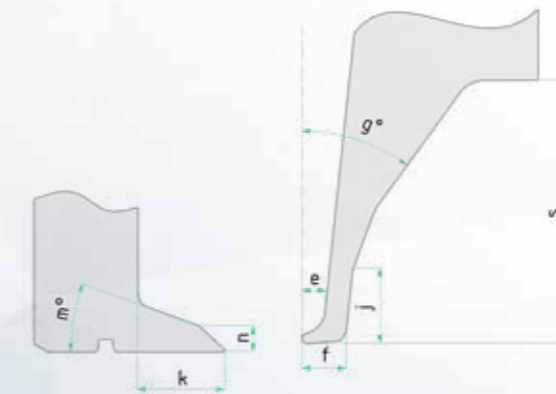
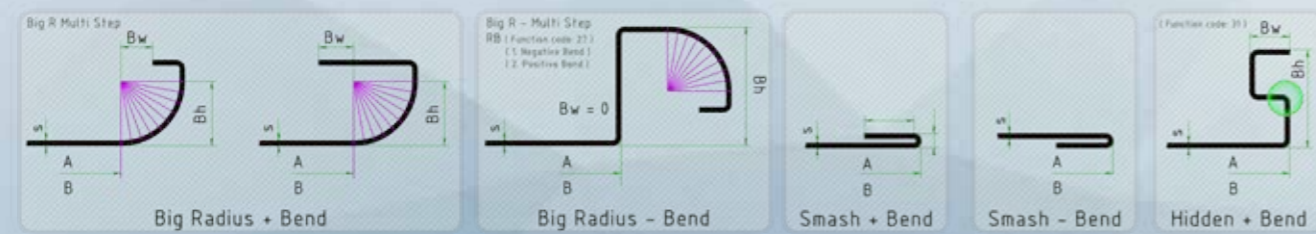
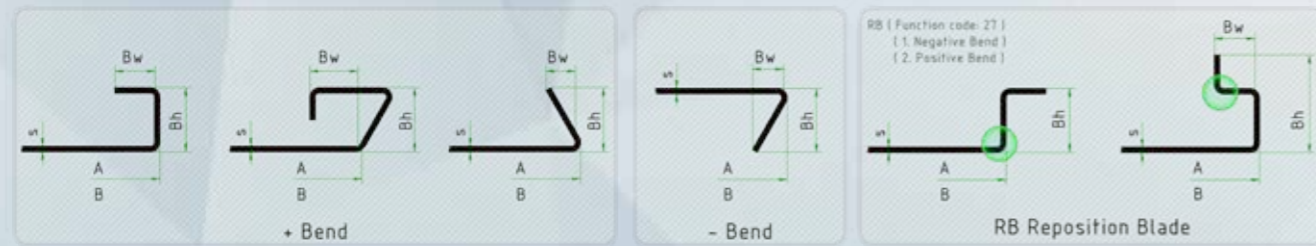
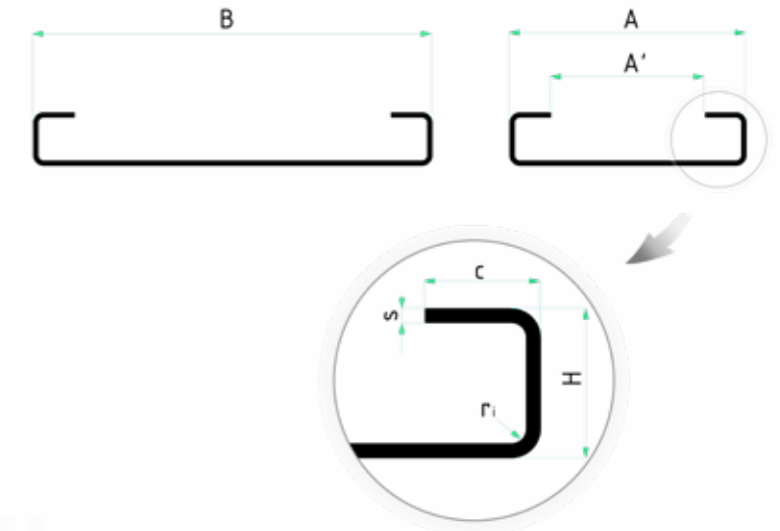
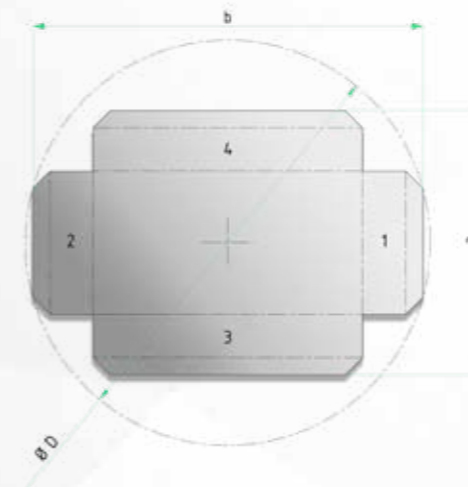
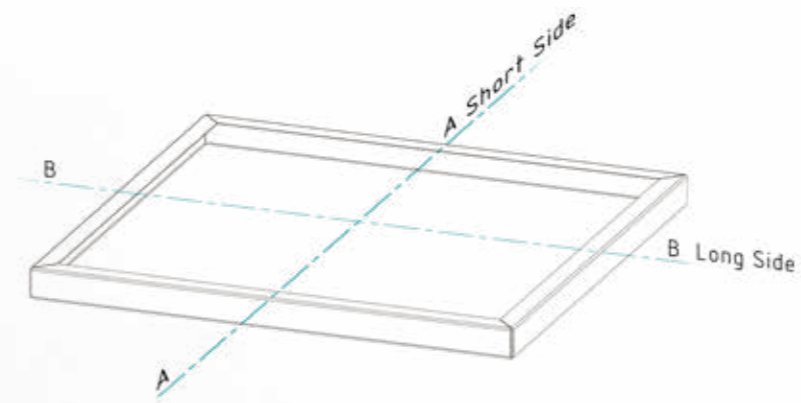

Upper Blade	e	mm	7,5
	f	mm	14
	g	°	36°
	j	mm	23,5
Lower Blade	u	mm	14
	q	mm	7,5
	w	mm	32
	w	mm	32
Upper Tool	k	mm	55
	n	mm	15
	m	°	20°
	r	mm	15
Lower Tool	p	mm	55
	v	°	20°

# Standard & Optional Equipment

## Standard Equipment

Universal Bending / Holding Tools  
 CAD-CAM software & Activator(Dongle)  
 Control Unit, Siemens Sinumerik 840 D SL Windows 7 operating system  
 Remote diagnostic function  
 Network, Ethernet communication  
 Programming on the control panel  
 ATS – Automatic Tool Setup  
 Standart Clamp for manipulator  
 Crowning Bending Device  
 Crowning Holder Device  
 Brush table  
 USB Driver  
 Air Condition for Electrical Cabinet  
 400 V Voltage  
 Barriers for CE  
 World standard electric equipment

## Optional Equipment

ABD – Auxiliary Bending Device  
 ABT – Auxiliary Bending Tools and Brackets  
 AHD – Auxiliary Holder Device  
 AHT – Auxiliary Holding Tools  
 OC - Over Clamp  
 NPF - Narrow Part Feeder  
 ENG - Engraver  
 Working Table (Brush & balls)  
 Loading / Unloading System  
 Transformator  
 UPS for machine (30 KvA 10 min.)

# Panel Bender Technical Details

Technical Specifications			
		PB2	PB4
Max. Bending Length	mm	2250	2800
Min. Bending Length	mm	350	350
Max. Sheet Entrance Length	mm	2600	3050
Max. Sheet Entrance Width	mm	1524	1524
Min. Bending Width	mm	150	150
Max. Bending Height	mm	254	254
Max. Bending Depth	mm	50	50
Max. Diagonal	mm	3300	3300
Bending Force	KN	320	500
Holding Force	KN	520	1000
<b>Max. Thickness of Sheet</b>			
for Fe 410 N/mm <sup>2</sup> Material	mm	2,6	3,2
for Inox 600 N/mm <sup>2</sup> Material	mm	1.8	2,2
for Aluminium 260 N/mm <sup>2</sup> Material	mm	3.5	4
Min. Thickness of Sheet	mm	0,5	0,5
Max. One Step Bending Angle	*	±135°	±135°
<b>Advanced Specification</b>			
Negative Last Bend		Standard	
Automatic Tool Setup		ATS (Standard)	
Inverse Bending Ranking		Standard	
Auxiliary Holder Tools		AHD (Option)	
Auxiliary Lower Bending Tools		AB (Option)	



PANEL BENDER



PUNCH



PRESS BRAKE



VARIABLE RAKE SHEAR



PLASMA



L ANGLE PROCESSING CENTER



LASER CUTTING

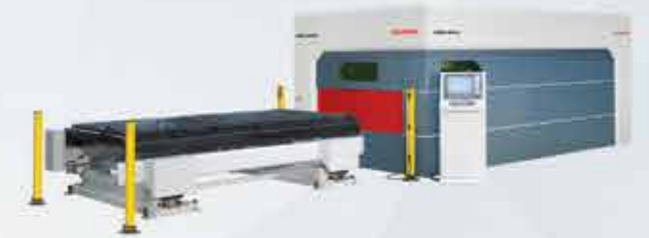

FIBER LASER



IRON WORKER



POWER OPERATED SHEAR



ROLL BENDING



PROFILE BENDING



CORNER NOTCHER

# DURMA

Bugün, Yarın ve Daima Sizlerle...

## PANEL BENDER CNC Büküm Merkezi

Durmazlar Makina San. ve Tic. A.Ş.  
OSB 75. Yıl Bulvarı Nilüfer-Bursa / Türkiye  
P: +90 224 219 18 00  
F: +90 224 242 75 80  
info@durmazlar.com.tr

www.durmazlar.com.tr



Durmazlar Makina San. Tic. A.Ş. katalog verilerini ve makine özelliklerini haber vermeksizin değişiklik yapma hakkına sahiptir.